

Two-Way Radios

User Guide



RMU2080 & RMV2080 Non-Display models

Open Source Software Legal Notices:

This Motorola product contains Open Source Software. For information regarding licenses, acknowledgements, required copyright notices and other usage terms, refer to the documentation for this Motorola product at:

<http://businessonline.motorolasolutions.com>

Go to: Resource Center > Product Information > Manual > Accessories.

CONTENTS

Contents	1
Product Safety	4
Introduction	5
Package Contents	5
FCC Licensing Information	7
Interference Information	7
Batteries and Chargers Safety Information	9
Operational Safety Guidelines	10
Radio Overview	11
Parts Of The Radio	11
On/Off/Volume Knob	12
Channel Selector Knob	12
Accessory Connector	12
Model Label	12
Microphone	12
Antenna	12
LED Indicator	12
Side Buttons	12
The Lithium-Ion (Li-Ion) Battery	12
Battery Features	14

About the Li-Ion Battery	14
Battery Recycling and Disposal	15
Installing the Lithium-Ion (Li-Ion) Battery	16
Removing the Lithium-Ion (Li-Ion) Battery	16
Holster	17
Power Supply, Adaptor and Drop-in Tray Charger	17
Battery Life Information	18
Charging the Battery	19
Drop-in Tray Charger LED Indicators	21
Estimated Charging Time	22
Multi-Unit Charger LED Indicators	24
Getting Started	26
Turning radio ON/OFF	26
Adjusting Volume	26
Selecting a Channel	26
Talking and Monitoring	26
Receiving a Call	27
Talk Range	27
Radio LED Indicators	29
Hands-Free Use/VOX	30

With Compatible VOX Accessories.	30	Example of Programming	
Setting VOX Sensitivity.	30	Auto-Scan	38
Microphone Gain.	31	Example of Programming Active	
Hands Free without Accessories		Channels	39
(iVOX).	31	Example of Programming	
Toggle Voice Prompt in User Mode	31	Weather Channels	39
Power Up - Tone Mode.	31	Other Programming Features	40
Reset to Factory Defaults	31	Scan.	40
Programming Features.	32	Editing Scan List	40
Advanced Configuration Mode	32	Nuisance Channel Delete	41
Entering Advanced Configuration		Customer Programming Software	
Mode.	33	(CPS).	41
Entering Frequencies Values	33	Time-Out Timer	42
Reading CTCSS / DPL Values	34	Power Select	42
Reading Auto-Scan Values.	34	Call Tones	42
Active Channels	34	Scramble	43
Weather Channel Programming	34	Reverse Burst	43
Saving Settings.	34	Weather Channel	44
Programming Values Example	37	NOAA Weather Alert	45
Example of Programming a		Cloning Radios.	47
Frequency.	37	Cloning with a Multi Unit Charger	
Example of Programming a		(MUC)	47
Code	38	CPS and Cloning Cables	

(Optional Accessory)	49	Software Applications	75
Cloning Radio using the Radio to Radio (R2R) Cloning Cable (Optional Accessory)	50	RM Series™ Features Summary	77
Cloning using the Customer Programming Software (CPS)	52	New Features	86
Troubleshooting	53	Programmable Buttons Chart	88
Use and Care	57		
Frequency and Code Charts	58		
RMV2080 – VHF Default Frequencies Chart	59		
RM UHF Frequencies Chart	60		
RMU2080 – UHF Default Frequencies Chart	63		
CTCSS and PL/DPL Codes	64		
Motorola Limited Warranty for the United States and Canada	70		
Accessories	74		
Audio Accessories	74		
Battery	74		
Cables	74		
Chargers	74		
Carry Accessories	75		

PRODUCT SAFETY

PRODUCT SAFETY AND RF EXPOSURE COMPLIANCE



Caution

Before using this product, read the operating instructions and RF energy awareness information contained in the Product Safety and RF Exposure booklet enclosed with your radio.

ATTENTION!

This radio is restricted to occupational use only to satisfy FCC RF energy exposure requirements.

For a list of Motorola-approved antennas, batteries and other accessories, visit the following website which lists approved accessories:

www.motorolasolutions.com/RMseries

INTRODUCTION

Thank you for purchasing the Motorola® RM Series™ Radio. This radio is a product of Motorola's 80 plus years of experience as a world leader in the designing and manufacturing of communications equipment. The RM Series™ radios provide cost-effective communications for businesses such as retail stores, restaurants, schools, construction sites, manufacturing, property and hotel management and more. Motorola professional two-way radios are the perfect communications solution for all of today's fast-paced industries.

Note: Read this user guide carefully to ensure you know how to properly operate the radio before use

**Business Radios,
Mailstop 1C15, Motorola
8000 West Sunrise Boulevard
Plantation, Florida 33322**

PACKAGE CONTENTS

- Radio
- Holster
- Lithium-Ion Battery
- Power Supply
- Quick Reference Guide
- Warranty Card
- Drop-in Tray Charger
- Product Safety & RF Exposure Booklet

For a copy of a large-print version of this user guide or for product-related questions, contact

1-800-448-6686 in the USA

1-800-461-4575 in Canada

1-888-390-6456 on TTY (Text Telephone)

For product related information, visit us at:

www.motorolasolutions.com/RMseries

FCC LICENSING INFORMATION

INTERFERENCE INFORMATION

This device complies with Part 15 of the FCC Rules. Operation is subject to the condition that this device does not cause harmful interference.

RM Series™ Business two-way radios operate on radio frequencies that are regulated by the Federal Communications Commission (FCC).

To transmit on these frequencies, you are required to have a license issued by the FCC. Application is made available on FCC Form 601 and Schedules D, H, and Remittance Form 159.

To obtain these FCC forms, request document 000601 which includes all forms and instructions. If you wish to have the document faxed, mailed or have questions, use the following contact information.

Faxed contact the Fax-On-Demand system at:	Mailed call the FCC forms hotline at:	Questions regarding FCC license contact the FCC at:
1-202-418-0177	1-800-418-FORM 1-800-418-3676	1-888-CALL-FCC 1-888-225-5322 Or: http://www.fcc.gov

Before filling out your application, you must decide which frequency(ies) you can operate on. See “Frequencies and Code Charts”. For questions on determining the radio frequency, call Motorola Product Services at:

1-800-448-6686

Changes or modifications not expressly approved by Motorola may void the user's authority granted by the FCC to operate this radio and should not be made. To comply with FCC requirements, transmitter adjustments should be made only by or under the supervision of a person certified as technically qualified to perform transmitter maintenance and repairs in the private land mobile and fixed services as certified by an organization representative of the user of those services.

Replacement of any transmitter component (crystal, semiconductor, etc.) not authorized by the FCC equipment authorization for this radio could violate FCC rules.

Use of this radio outside the country where it was intended to be distributed is subject to government regulations and may be prohibited

BATTERIES AND CHARGERS SAFETY INFORMATION

This document contains important safety and operating instructions. Read these instructions carefully and save them for future reference.

Before using the battery charger, read all the instructions and cautionary markings on

- the charger,
 - the battery, and
 - the radio using the battery
1. To reduce risk of injury, charge only the rechargeable Motorola-authorized batteries. Other batteries may explode, causing personal injury and damage.
 2. Use of accessories not recommended by Motorola may result in risk of fire, electric shock, or injury.
 3. To reduce risk of damage to the electric plug and cord, pull by the plug rather than the cord when disconnecting the charger.
 4. An extension cord should not be used unless absolutely necessary. Use of an improper extension cord could result in risk of fire and electric shock. If an extension cord must be used, make sure that the cord size is 18AWG for lengths up to 100 feet (30.48 m), and 16AWG for lengths up to 150 feet (45.72 m).
 5. To reduce risk of fire, electric shock, or injury, do not operate the charger if it has been broken or damaged in any way. Take it to a qualified Motorola service representative.
 6. Do not disassemble the charger; it is not repairable and replacement parts are not available. Disassembly of the charger may result in risk of electrical shock or fire.
 7. To reduce risk of electric shock, unplug the charger from the AC outlet before attempting any maintenance or cleaning

OPERATIONAL SAFETY GUIDELINES

- Turn the radio OFF when charging battery.
 - The charger is not suitable for outdoor use. Use only in dry locations/conditions.
 - Connect charger only to an appropriately fused and wired supply of the correct voltage (as specified on the product).
 - Disconnect charger from line voltage by removing main plug.
 - The outlet to which this equipment is connected should be nearby and easily accessible.
 - In equipment using fuses, replacements must comply with the type and rating specified in the equipment instructions.
 - Maximum ambient temperature around the power supply equipment must not exceed 40°C (104°F).
 - Power output from the power supply unit must not exceed the ratings stated on the product label
- located at the bottom of the charger.
- Make sure that the cord is located where it will not be stepped on, tripped over, or subjected to water, damage, or stress.

RADIO OVERVIEW

PARTS OF THE RADIO

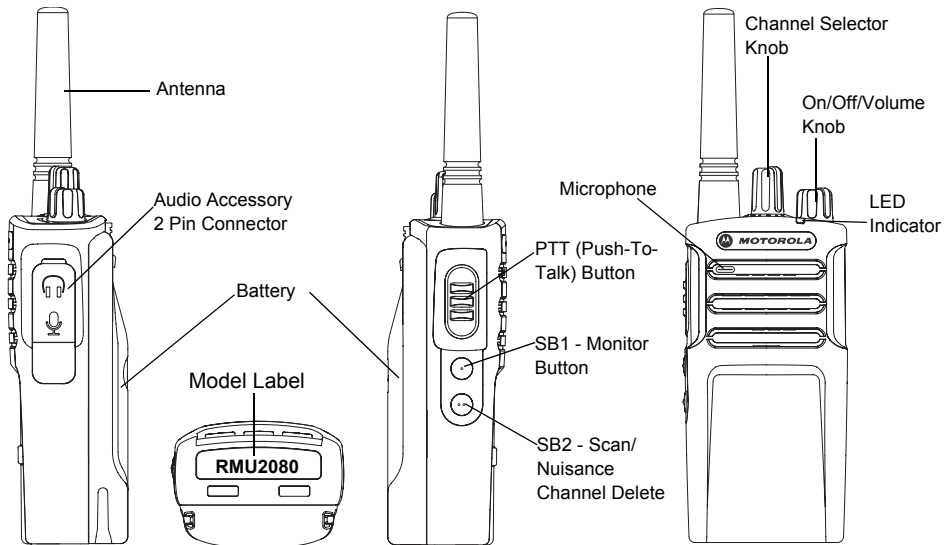

On/Off/Volume Knob

Used to turn the radio ON or OFF and to adjust the radio's volume.

Channel Selector Knob

Used to switch the radio to different channels.

Accessory Connector

Used to connect compatible audio accessories.

Model Label

Indicates the model of the radio.

Microphone

Speak clearly into the microphone when sending a message.

Antenna

For models **RMU2080**, and **RMV2080** the antennas are non-removable.

LED Indicator

Used to give battery status, power-up status, radio call information and scan status.

Side Buttons***Push-to-Talk (PTT) Button***

- Press and hold down this button to talk, release it to listen.

Side Button 1 (SB1)

- The Side Button 1 is a general button that can be configured by the Customer Programming Software - CPS. The default setting of SB1 is 'Monitor'.

Side Button 2 (SB2)

- The Side Button 2 is a general button that can be configured by the CPS. The SB2 default setting is 'Scan/Nuisance Channel Delete'.

The Lithium-Ion (Li-Ion) Battery

RM Series comes with a Standard Capacity Li-Ion battery. Other batteries may be available. For more information, see "Battery Features" on page 14.

This User Guide covers multiple RM Series models, and may detail some features your radio does not have. The radio's model is shown on the bottom of the radio and provides the following information:

Table 1: RM Series Radio Specifications

Model	Frequency Band	Transmit Power (Watts)	Number of Channels	Antenna
RMU2080	UHF	2	8	Non-removable
RMV2080	VHF	2	8	Non-removable

BATTERY FEATURES

RM Series radios provide Lithium-Ion batteries that come in different capacities that defines the battery life.

About the Li-Ion Battery

The RM Series radio comes equipped with a rechargeable Li-Ion battery. This battery should be fully charged before initial use to ensure optimum capacity and performance.

Battery life is determined by several factors. Among the more critical are the regular overcharge of batteries and the average depth of discharge with each cycle. Typically, the greater the overcharge and the deeper the average discharge, the fewer cycles a battery will last. For example, a battery which is overcharged and discharged 100% several times a day, lasts fewer cycles than a battery that receives less of an overcharge and is discharged to 50% per day. Further, a battery which receives minimal overcharging and

averages only 25% discharge, lasts even longer.

Motorola batteries are designed specifically to be used with a Motorola charger and vice versa. Charging in non-Motorola equipment may lead to battery damage and void the battery warranty. The battery should be at about 77°F (25°C) (room temperature), whenever possible. Charging a cold battery (below 50° F [10°C]) may result in leakage of electrolyte and ultimately in failure of the battery. Charging a hot battery (above 95°F [35°C]) results in reduced discharge capacity, affecting the performance of the radio. Motorola rapid-rate battery chargers contain a temperature-sensing circuit to ensure that batteries are charged within the temperature limits stated above.

Battery Recycling and Disposal

Li-Ion rechargeable batteries can be recycled. However, recycling facilities may not be available in all areas. Under various U.S. state laws and the laws of several other countries, batteries must be recycled and cannot be disposed of in landfills or incinerators. Contact your local waste management agency for specific requirements and information in your area. Motorola fully endorses and encourages the recycling of Li-Ion batteries. In the U.S. and Canada, Motorola participates in the nationwide Rechargeable Battery Recycling Corporation (RBRC) program for Li-Ion battery collection and recycling.

Many retailers and dealers participate in this program. For the location of the drop-off facility closest to you, access RBRC's Internet web site at:

www.rbrc.com

or call:

1-800-8-BATTERY

This internet site and telephone number also provides other useful information concerning recycling options for consumers, businesses and governmental agencies.

Installing the Lithium-Ion (Li-Ion) Battery

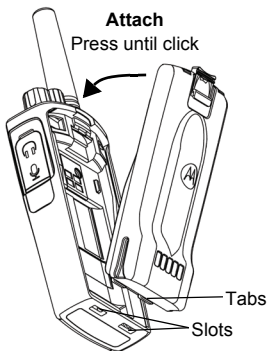

1. Turn OFF the radio.
2. With the Motorola logo side up on the battery pack, fit the tabs at the bottom of the battery into the slots at the bottom of the radio's body.
3. Press the top part of the battery towards the radio until a click is heard.

Note: To learn about the Li-Ion Battery Life features, refer to "About the Li-Ion Battery" on page 14

Removing the Lithium-Ion (Li-Ion) Battery

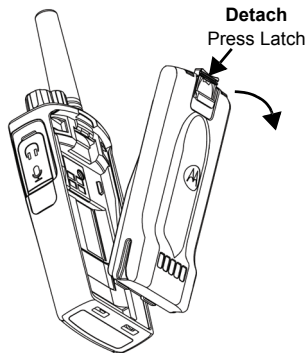

1. Turn OFF the radio.
2. Push down the battery latch and hold it while removing the battery.
3. Pull the battery away from the radio.

Holster

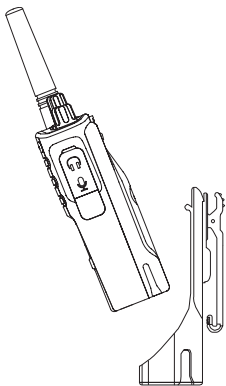

1. Insert the radio into the base of the holster at an angle. Press the radio against the back of the holster until the hooks on the holster are inserted in the top recesses of the battery.
2. To remove, using the top tab on the holster, detach the hooks of the holster from the top recesses of the battery. Slide the radio at an angle and remove from the holster.

Power Supply, Adaptor and Drop-in Tray Charger

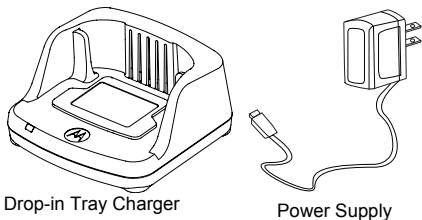

The radio is equipped with one Drop-in Tray Charger and one Power Supply with Adaptor. For more information, refer to “Chargers” on page 74.

Battery Life Information

When the Battery Save feature is set to ON (enabled by default), the battery life lasts longer. The following table summarizes battery life estimations:

Table 2: Li-Ion Battery Life with Tx Power 2 Watts

Battery Type	Battery Save OFF	Battery Save ON
Standard	12 Hours	15 Hours
High Capacity	N/A	N/A

Note: Battery life is estimated based on 5% transmit / 5% receive / 90% standby standard duty cycle.

Charging the Battery

The RM Series radio offers two types of Power Supplies:

- Standard Power Supply and,
- Rapid Power Supply

Note: The radio comes with a Standard Power Supply.

To charge the battery (with the radio attached), place it in a Motorola-approved Drop-in Tray Single Unit Charger or Drop-in Tray Multi Unit Charger.

Charging with the Drop-in Tray Single Unit Charger (SUC)

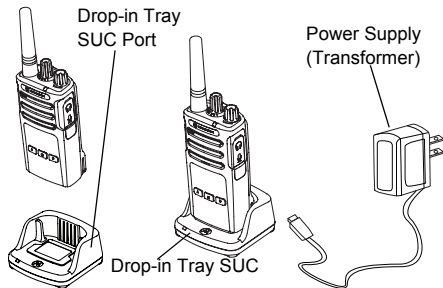

1. Place the Drop-in Tray Charger on a flat surface.
2. Insert the connector of the Power Supply into the charger port on the back of the Drop-in Tray Charger.
3. Plug the AC Adaptor into a power outlet.
4. Insert the radio into the Drop-in Tray Single Unit Charger with the radio facing the front, as shown.

Note: When charging a battery attached to the radio, turn the radio OFF to ensure a full charge. See “Operational Safety Guidelines” on page 10 for more information.

Charging A Stand-Alone Battery

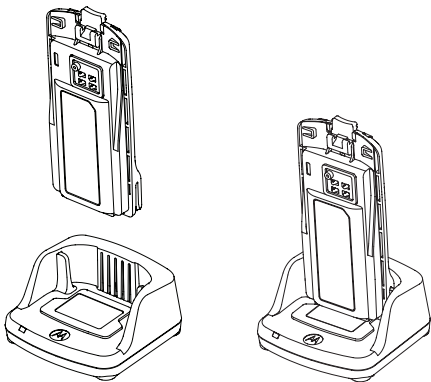

To charge only the battery - at step 4 on page 19, insert the battery into the tray, with the inside surface of the battery facing the front of the Drop-in Tray Single Unit Charger as shown









above. Align the slots in the battery with the alignment ribs in the Drop-in Tray Single Unit Charger.

Table 3: Motorola Authorized Batteries

Part Number	Description
PMNN4434_R	Standard Li-Ion Battery
PMNN4453_R	High Capacity Li-Ion Battery

Drop-in Tray Charger LED Indicators

Table 4: Charger LED Indicator

Status	LED Indicator	Comments
Power On	Green for approximately 1 second 	
Charging	Steady Red 	
Charging Complete	Steady Green 	
Battery Fault (*)	Red Fast Flash 	
Waiting to Charge (**)	Amber Slow Flash 	
Battery Level Status	N/A	Battery empty
	Flash Red 1 Time 	Battery low
	Flash Amber 2 Times 	Battery medium
	Flash Green 3 Times 	Battery High

(*) Normally, re-positioning the battery pack will correct this issue.

(**) Battery temperature is too warm or too cold or wrong power voltage is being used.

If there is NO LED indication:

1. Check if the radio with battery, or the battery alone, is inserted correctly. (refer to step 4 of "Charging with the Drop-in Tray Single Unit Charger (SUC)" on page 19)
2. Ensure that the power supply cable is securely plugged into the charger socket using an appropriate AC outlet and there is power to the outlet.
3. Confirm that the battery being used with the radio is listed in Table 3 on page 20.

Estimated Charging Time

The following table provides the estimated charging time of the battery. For more information, see "Battery" on page 74.

Table 5: Battery Estimated Charging Time

Charging Solutions	Estimated Charging Time	
	Standard Battery	High Capacity Battery
Standard	≤ 4.5 Hours	N/A
Rapid	≤ 2.5 Hours	N/A

Charging a Radio and Battery using a Multi Unit-Charger - MUC (Optional Accessory)

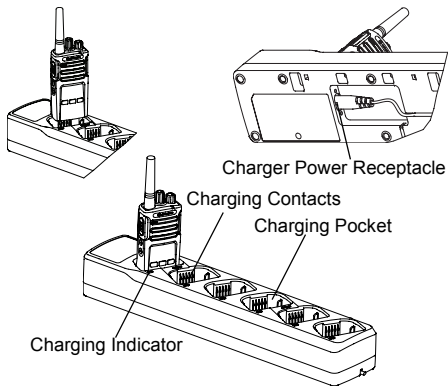

The Multi-Unit Charger (MUC) allows drop-in charging of up to 6 radios or batteries. Batteries can be charged with the radios or removed and placed in the MUC separately. Each of the 6 charging pockets can hold a radio (with or without the Holster) or battery, but not both.









1. Place the Multi-Unit Charger on a flat surface.
2. Insert the power cord plug into the MUC's dual pin connector at the bottom of the MUC.
3. Plug the power cord into an AC outlet.
4. Turn the radio OFF.
5. Insert the radio or battery into the charging pocket with the radio or battery facing away from the contacts.

Note:

- This Multi-Unit Charger clones up to 2 radios (2 Source radios and 2 Target radios). Refer to "Cloning with a Multi Unit Charger (MUC)" on page 47 for more information.
- More information on the Multi-Unit Charger's operation is available in the Instruction Sheets provided with the MUC. For more information on the parts and their part numbers, refer to Chapter "Accessories" on page 74.

Multi-Unit Charger LED Indicators

Table 6: Charger LED Indicator

Status	LED Indicator	Comments
Power On	Green for approximately 1 second 	
Charging	Steady Red 	
Charging Complete	Steady Green 	
Battery Fault (*)	Red Fast Flash 	
Waiting to Charge (**)	Amber Slow Flash 	
Battery Level Status	N/A	Battery empty
	Flash Red 1 Time 	Battery low
	Flash Amber 2 Times 	Battery medium
	Flash Green 3 Times 	Battery High

(*) Normally, re-positioning the battery pack will correct this issue.

(**) Battery temperature is too warm or too cold or wrong power voltage is being used.

If there is NO LED indication:

1. Check if the radio with battery or the battery alone, is inserted correctly (refer to step 5 of "Charging a Radio and Battery using a Multi Unit-Charger - MUC (Optional Accessory)" on page 23).
2. Make sure the power cord is securely plugged into the MUC and the appropriate AC outlet. Make sure there is power to the AC outlet.
3. Confirm that the battery being used with the radio is listed in Table 3 on page 20.

GETTING STARTED

For the following explanations, refer to “Parts Of The Radio” on page 11.

TURNING RADIO ON/OFF

To turn ON the radio, rotate the On/Off/Volume Knob clockwise. The radio plays one of the following:

- Power up tone and channel number announcement, or
- Battery level and channel number announcements, or
- Silent (Audible tones disabled)

The LED blinks red briefly.

To turn the radio OFF, rotate the On/Off/Volume Knob counterclockwise until you hear a ‘click’ and the radio LED Indicator turns OFF.

ADJUSTING VOLUME

Turn the On/Off/Volume Knob clockwise to increase the volume, or counterclockwise to decrease the volume.

Note: Do not hold the radio too close to the ear when the volume is high or when adjusting the volume

SELECTING A CHANNEL

To select a channel, turn the Channel Selector Knob until you reach the desired channel. An audible voice indicates the selected channel.

Each channel has its own Frequency, Interference Eliminator Code and Scan Settings.

TALKING AND MONITORING

It is important to monitor for traffic before transmitting to avoid ‘talking over’ someone who is already transmitting

To monitor, long press and hold the SB1(*) button to access channel traffic. If no activity is present, you will hear ‘static’. To release, press SB1 again. Once channel traffic has cleared, proceed with your call by pressing the PTT button. When transmitting, the LED Indicator stays solid red.

Notes:

- To listen to all activity on a current channel, short press the SB1 to set the CTCSS/DPL code to 0. This feature is called 'CTCSS/DPL Defeat (Squelch set to SILENT)'.
- (*) This assumes SB1 is not being programmed for a different mode.

RECEIVING A CALL

1. Select a channel by rotating the Channel Selector Knob until you reach the desired channel. An audible voice indicates the selected channel.
2. Make sure the PTT button is released and listen for voice activity.
3. The LED Indicator stays solid red when the radio is receiving a call.
4. To respond, hold the radio vertically 1 to 2 inches (2.5 to 5cm) from mouth. Press the PTT button to talk; release it to listen.

TALK RANGE

TALK RANGE		
Model	Industrial	Multi-Level
	Inside steel/ concrete Industrial buildings	Inside multi- level buildings
UHF 2W	Up to 250,000 Sq. Ft.	Up to 20 Floors
VHF 2W	Up to 220,000 Sq. Ft.	Up to 13 Floors

To establish a proper two-way communication, the channel, frequency, and interference eliminator codes must be the same on both radios. This depends on the stored profile that has been preprogrammed on the radio:

1. **Channel:** Current channel that the radio is using, depending on radio model.
2. **Frequency:** The frequency the radio uses to transmit/receive.
3. **Interference Eliminator Code:** These codes help minimize interference by providing a choice of code combinations.

4. **Scramble Code:** Codes that make the transmissions sound garbled to anyone listening who is not set to that specific code.
5. **Bandwidth:** Some frequencies have selectable channel spacing, which must match other radios for optimum audio quality.

For details on how to set up frequencies and CTCSS/DPL codes in the channels, refer to “Advanced Configuration Mode” on page 32.

RADIO LED INDICATORS

RADIO STATUS	LED INDICATION
Channel Busy	Solid Orange
Cloning Mode	Double Orange Heartbeats
Cloning In Progress	Solid Orange
Fatal Error at Power up	One Green Blink, One Orange Blink, One Green Blink, then repeat for 4 seconds
Low Battery	Orange Heartbeat
Low Battery Shutdown	Fast Orange Heartbeat
Monitor	LED is OFF
Power-Up	Solid Red for 2 seconds
'Idle' Programming Mode / Channel Mode	Green Heartbeat
Scan Mode	Fast Red Heartbeat
Transmit (Tx)/Receive (RX)	Solid Red
Transmit in Low Power Select	Solid Orange
VOX/iVOX Mode	Double Red Heartbeats

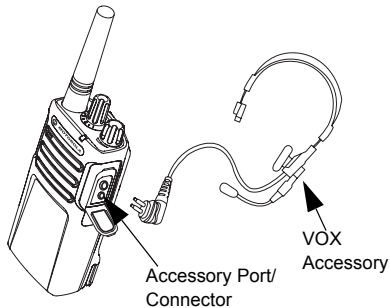
HANDS-FREE USE/VOX

Motorola RM Series™ radios can operate hands-free (VOX) when used with compatible VOX accessories.

With Compatible VOX Accessories

The default factory setting for VOX sensitivity level is OFF (level '0'). Before using VOX, set VOX level to a level different from '0' via the Customer Programming Software (CPS). Then, perform the following steps:

1. Turn the radio OFF.

2. Open accessory cover.
3. Insert the audio accessory's plug firmly into accessory port.
4. Turn radio ON. The LED Indicator will blink double red
5. Lower radio volume BEFORE placing accessory near ear.
6. To transmit, speak into accessory microphone and to receive, stop talking.
7. VOX can be temporarily disabled by pressing the PTT button or by removing the audio accessory.

Note: To order accessories, refer to: www.motorolasolutions.com/RMseries, call 1 (800) 448-6686, or contact your Motorola point of purchase

Setting VOX Sensitivity

The sensitivity of the radio's accessory or microphone can be adjusted to suit different operating environments. VOX sensitivity can be programmed via the CPS.

Default value is OFF. If you want to use the VOX feature, VOX level should be set at a different level.

- 1 = High audio input level will trigger the Tx
- 2 = Medium sensitivity
- 3 = Low audio input level will trigger the Tx

Microphone Gain

The sensitivity of the microphone can be adjusted to fit different users or operating environments.

This feature can be adjusted only through the CPS. Microphone default setting is set to level 2 (medium gain).

Hands Free without Accessories (iVOX)

- Enable iVOX by pressing the PTT Button while turning ON the radio.
- A short press of the PTT Button re-enables iVOX.
- There is a short delay between the time when you start talking and when the radio transmits.

Toggle Voice Prompt in User Mode

Short press the SB1 Button while turning ON the radio to enable/disable the Voice Prompt in User Mode. (Default is set to ON).

Note: This setting is set to OFF by default and must be enabled using the CPS.

Power Up - Tone Mode

To enable/disable power up tone mode, press SB1 and SB2 buttons simultaneously for 2-3 seconds while powering up the radio until you hear the pre-programmed power up tone. 3 different power-up tones are available.

Reset to Factory Defaults

Reset to Factory Defaults will set back all radio features to the original factory default settings. To do so, press PTT, SB2 and SB1 simultaneously while turning ON the radio until you hear a high tone chirp.

PROGRAMMING FEATURES

To easily program all the features in your radio, it is recommended to use the Customer Programming Software (CPS) and the programming cable.

CPS software download is available for free at www.motorolasolutions.com/RMSeries.

ADVANCED CONFIGURATION MODE

Advanced Configuration is a configuration mode that allows the customization of additional features via the radio's front panel.

For non-display model radios, the navigation is guided by an audible voice prompt.

When the radio is set to Advanced Configuration, you are able to read and modify four features:

- Frequency Selection,
- Codes (CTCSS/DPL),

- Auto-Scan,
- Active Channels, and
- Enable/Disable/Program the Weather Channel

The **Frequencies Select** feature allows you to choose frequencies from a pre-defined list.

The **Interference Eliminator Code** (CTCSS/DPL) helps minimize interference by providing you with a choice of code combinations that filter out static, noise, and unwanted messages.

The **Auto-Scan** feature allows you to set a particular channel to automatically enable Scan each time you switch to that channel.

The **Active Channels** feature allows you to increase or decrease the amount of active channels (In the range of maximum channels allowed).

The **Weather Programming** feature allows you to alternate the channel function between 2 way radio channel and weather channel. There

are 7 received frequencies available for this feature.

Entering Advanced Configuration Mode

Note: Before configuring the features, make sure your radio is set to the channel you wish to program. You can do so before entering Advanced Configuration Mode or at any time during the Advanced Configuration Mode by rotating the Channel Selector Knob until you reach the desired channel.

To read or modify Frequencies, Codes, Auto-Scan, Active Channels and Weather Channel set the radio to 'Advanced Configuration Mode' by long pressing both the PTT and the SB1 button simultaneously for 3 to 5 seconds while turning ON the radio until you hear an audible voice saying "Programming Mode" and "Channel Number". The LED Indicator starts blinking a green heartbeat.

Note: 'Idle' Programming Mode is the stage in the Programming Mode where the radio waits

for the user to start the radio programming cycle.

Once you are in the 'Idle' Programming Mode, you will be able to hear the Frequencies, Codes, Auto-Scan, Active Channels and Weather Channel settings by short pressing the PTT button to navigate along the different programmable features.

Entering Frequencies Values

RM Series radios have 89 frequencies for UHF and 27 frequencies for VHF.

In 'Idle' Programming mode, the Channel number becomes the first changeable value. Select the desired channel by turning the Channel Selector Knob. An audible voice indicated the selected channel to configure. Short pressing the PTT button allows you to cycle through the other features available for configuration. Use the SB1 and SB2 button to change the values. An audible voice indicates the value selected.

Reading CTCSS / DPL Values

Cycle through the features available for configuration by short pressing the PTT button until you hear the current code. The radio moves to the programming CTCSS/PL codes mode.

Enter a new code value using the SB1 and SB2 buttons.

The RM Series radios have up to 219 codes available. For more information, refer to “Frequency and Code Charts” on page 58.

Reading Auto-Scan Values

After hearing the CTCSS/DPL codes, short pressing the PTT button moves you to Auto-Scan mode.

Auto-Scan has only two values:

- Enabled
- Disabled

Active Channels

While in Auto-Scan mode, short pressing the PTT button shifts the radio to ‘Active Channels’ feature.

Modify the amount of channels available using the SB1 and SB2 buttons.

Weather Channel Programming

After setting the amount of Active Channels, short pressing the PTT button moves you to Weather Channel feature.

Use the SB1 and SB2 buttons to Enable/Disable the feature.

Saving Settings

Once you are satisfied with the settings, you can either:

- short press the PTT button to continue programming,
- long press the PTT button to save and return to ‘Idle’ Programming Mode, or
- long press the PTT button twice to exit ‘Idle’

Programming Mode and return to the normal radio operation.

Note:

- To exit the programming mode without saving, turn OFF the radio.
- If you 'roll-over' to the beginning of 'Idle' Programming Mode, you will hear "Channel Number" and the LED Indicator blinks green again. All changed values will be automatically saved.

Programming Mode FAQ

1. *I got distracted while programming and forgot which feature I was programming. What should I do?*

Return to 'Idle' Programming Mode and start over. You will not be able to return to Programming Mode (the radio does not provide further way to let you know the specific stage you are at in the Programming Mode). Therefore you can:

- Long press the PTT button. The radio will return to 'Idle' Programming Mode or,
 - Turn OFF the radio and enter Programming Mode again. (Refer to "Entering Advanced Configuration Mode" on page 33 for more information)
2. *I am trying to program a frequency (or a code) value but the radio would not do it. It rolled over and took me back to value '0'.*

The radio disallow you to program any value that is not available in the frequencies and

codes pool. For example, if you try to program code 220, the radio would not accept it as the maximum value allowed is 219. Same goes for the frequencies. Refer to the "Frequency and Code Charts" on page 58 to make sure you are programming a valid value.

3. *I am trying to enter the Programming Mode but the radio would not do it.*

The radio may be locked using the CPS to disallow Front Panel Programming. To re-enable, use the CPS.

4. *I programmed the wrong value when I was programming. How can I erase or re-program the value?*

If you programmed the wrong value, you can either:

- 'Roll-over' the radio. The radio 'roll-over' each time it reaches the maximum value allowed. Keep increasing (short press the SB1 button) or decreasing (short press the SB2 button) until you get the desired value or,

- Turn OFF the radio and start over.
5. *I just programmed the value I wanted. How do I exit the Programming Mode?*

You can either:

- long press the PTT button twice to exit if you're in the Programming Mode or,
 - Long press the PTT button once if you are already in the 'Idle' Programming mode.
6. *I am done programming the features in this channel. How do I program another channel?*

Short press the PTT button several times until you hear "Channel Number". Switch channel by rotating the Channel Selector Knob. If you wish to save the changes, make sure you are in the 'Idle' Programming Mode before switching the channel, otherwise you will lose the changes made.

PROGRAMMING VALUES EXAMPLE

Example of Programming a Frequency

Assuming current frequency value is set to **Channel 1**, with the UHF default frequency set to **'02'** (equivalent to 464.5500 MHz), and you want to change it to **Frequency Number = '13'** (which is mapped to 461.1375 MHz), follow this sequence:

1. Enter Advanced Configuration Mode.
2. Short press the PTT button to enter Frequency Mode. The radio audible voice announces that the current value is '2'.
3. Press the SB1 button eleven times to increase frequencies and you will hear frequency "One, three" (13).
4. Long press the PTT button. LED Indicator shows a green heartbeat to indicate 'Idle' Programming Mode.
5. Long press the PTT button again to exit Programming Mode or turn OFF the radio.

Example of Programming a Code

Assuming the current code value is set to factory default '001', and you want to change it to **CTCSS/DPL Code = 103**. Follow the sequence indicated below:

1. Enter Advanced Configuration Mode.
2. Short press the PTT button twice. The radio audible voice announced "Code Number" (Entering CTCSS/DPL Programming Selection Mode).
3. Pressing and holding SB1 or SB2 button fast forwards / rewinds the value at the nearest 10's. When released, the radio audible voice announces the first, second and third digit in full. Keep pressing the SB1 or SB2 button several times until you hear "103".
4. Long press the PTT button. LED Indicator shows a green heartbeat to indicate 'Idle' Programming Mode.
5. Long press the PTT button again to exit Programming Mode or turn OFF the radio.

Example of Programming Auto-Scan

Auto-Scan is the third available feature in the Programming Mode and can be set to either ON or OFF on a particular channel.

To set Auto-Scan to ON:

- Enter Advanced Configuration Mode and select the desired channel.
- Short press the PTT button three times to enter the Active Channels Programming Selection Mode. The audible voice in the radio announces "Auto-Scan" and the setting (Enabled or Disabled).
- To change the setting, press SB1 or SB2.
- Long press the PTT button. LED Indicator shows a green heartbeat to indicate 'Idle' Programming Mode.
- Long press the PTT button again to exit Programming Mode or turn OFF the radio.

Example of Programming Active Channels

Active Channels is the fourth Programming Mode. It allows you to modify the number of active channels the radio is programmed to support.

To set Active Channels:

- Enter Advanced Configuration Mode and select the desired channel.
- Short press the PTT button four times to enter the Active Channels Programming Selection Mode. The audible voice in the radio announces “Active Channels” and the current value.
- Short press the SB1 or SB2 button until you get the number of channels desired.
- Long press the PTT button. LED Indicator shows a green heartbeat to indicate ‘Idle’ Programming Mode.
- Long press the PTT button to exit Programming Mode or turn OFF the radio.

Example of Programming Weather Channels

Weather Channels is the last Programming mode. It allows you to toggle a radio channel between 2 way radio mode and weather alert mode.

To set channels to Weather Alert Mode:

- Enter Advanced Configuration Mode and select the desired channel.
- Short press the PTT button five times to enter the Weather Channels Programming Mode.
- An audible voice announces “Weather Channel and Frequency Used: and instructions on how to change the values.
- Short press the SB1 or SB2 button to enable/disable the feature.
- Long press the PTT button. LED Indicator shows a green heartbeat to indicate ‘Idle’ Programming Mode.
- Long press the PTT button again to exit Programming mode or turn OFF the radio.

OTHER PROGRAMMING FEATURES

Scan

Scan allows you to monitor other channels to detect conversations. When the radio detects a transmission, it stops scanning and goes to the active channel. This allows you to listen and talk to people in that channel without having to change channel manually. If there are transmissions on another channel, you will not hear that activity once the radio has stopped scanning. Once the activity on transmitting channel stops, the radio waits for 5 seconds before resuming scan again.

- To start scanning, press the SB1 or SB2 button

Note: Scan has to be programmed either to SB1 or SB2 button via CPS. SB2 is by default Scan/Nuisance Channel delete button.

- To stop scanning, short press the SB1 or SB2 button (programmed for scan) again.
- By pressing the PTT button while the radio is scanning, the radio will transmit on the channel which was previously selected before Scan is

activated. If no transmission occurs within 5 seconds, scanning resumes.

- If you want to scan a channel without the Interference Eliminator Codes (CTCSS/DPL), set the code settings for the channels to '0' in the CTCSS/DPL Programming Selection Mode.

Note: Whenever the radio is set to Scan, the LED Indicator blinks a Red Heartbeat.

Editing Scan List

Scan List can be edited by using the CPS. For more information refer to “Customer Programming Software (CPS)” on page 41.

Nuisance Channel Delete

Nuisance Channel Delete allows you to temporarily remove channels from the Scan List. This feature is useful when irrelevant conversations on a 'nuisance' channel ties up the radio's scanning feature.

To delete a channel from the Scan List:

- Start Scan mode by short pressing the SB1 or SB2 (programmed for scan) button.
- Wait until the radio stops at the channel you wish to eliminate. Long press the SB2 button to delete it. You cannot delete the channel with scan enabled (home channel).
- The channel will not be scanned again until you exit the Scan mode by short pressing the SB1 or SB2 (programmed for scan) button again or by turning OFF the radio and back ON.

CUSTOMER PROGRAMMING SOFTWARE (CPS)

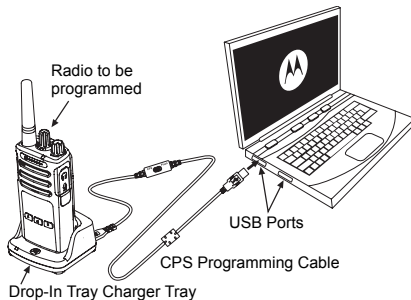

Figure 1: Setting up the radio to the CPS

The easiest way to program or change features in your radio is by using the Customer Programming Software (CPS) and the CPS Programming Cable(*). CPS Software is available for free as web based downloadable software at:

www.motorolasolutions.com/RMseries

To program, connect the RM Series radio via the Drop-in Charger Tray and CPS Programming Cable as shown in **Figure 1 on page 41**. Toggle the cable switch of the CPS Programming Cable to '**CPS Mode**'.

CPS allows you to program frequencies, PL/DPL Codes as well as other features such as: Bandwidth Select, Time-out Timer, Power Select, Scan List, Call Tones, Scramble, Reverse Burst, etc. CPS is a very useful tool as it can also lock the Front-Panel Radio Programming or restrict any specific radio feature to be changed (to avoid accidentally erasing the preset radio values). It also provides security by giving the option to set up a password for profile radio's management. For more information, refer to Features Summary Chart Section at the end of the User Guide.

Note: (*) CPS Programming Cable P/N# HKKN4027_ is an accessory sold separately. Please contact your Motorola point of purchase for more information.

Time-Out Timer

This timer sets the amount of time that the radio can continuously transmit before the transmission is automatically terminated. The default setting is 60 seconds and can be changed using the CPS.

Power Select

Power Select allows you to select between high and low transmission power per frequency in each channel. The power levels for RM Series 2W toggle between 1W and 2W.

Call Tones

Call Tones feature allows you to transmit an audible tone to other radios on the same channel to alert them that you are about to talk or to alert them without speaking.

To use this feature, the Call Tones must be programmed to either SB1 or SB2 and 1 of the 3 pre-recorded tones is selected.

Scramble

The Scramble feature makes transmissions sound garbled to anyone listening without the same code. Scramble default value is OFF. To change the scramble code during radio's normal operation, the Scramble feature must be programmed to either SB1 or SB2.

Reverse Burst

Reverse Burst eliminates unwanted noise (squelch tail) during loss of carrier detection. You can select values of either 180 or 240 to be compatible with other radios. The default value is 180.

Notes:

- The features described in previous pages are just some of the features CPS has. CPS offers more capabilities. For more information refer to the HELP file in the CPS.
- Some of the features available with the CPS software may vary depending on the radio model.

WEATHER CHANNEL

NOAA Weather Radio All Hazards (NWR) is a nationwide network of radio stations broadcasting continuous weather information directly from the nearest National Weather Service office. NWR broadcasts official Weather Service warnings, watches, forecasts and other hazard information 24 hours a day, 7 days a week.

Working with the Federal Communication Commission's (FCC) Emergency Alert System, NWR is an "All Hazards" radio network, making it your single source for comprehensive weather and emergency information. In conjunction with Federal, State and Local Emergency Managers and other public officials, NWR also broadcasts warning and post-event information for all types of hazards – including natural (such as earthquakes or avalanches), environmental (such as chemical releases or oil spills), and public safety (such as AMBER alerts or 911 Telephone outages).

Known as the "Voice of NOAA's National Weather Service", NWR is provided as public service by the National Oceanic and Atmospheric Administration (NOAA), part of the Department of Commerce. NWR includes 1000 transmitters, covering all 50 states, adjacent coastal waters, Puerto Rico, the U.S. Virgin Islands and the U.S. Pacific Territories. NWR requires a special radio receiver or scanner capable of picking up the signal. Broadcasts are found in the VHF public service band at these seven frequencies.

Public Service Band Frequencies (MHz)	
162.400	162.425
162.450	162.475
162.500	162.525
162.550	

The channel position 8 on all RM Series radios with channel selector knob is configured at the factory as a NOAA Weather Radio.

The NOAA Weather Radio feature can be disabled or configured to any of the other available channel positions via the Customer Programming Software (CPS) or in Advanced Configuration Mode. When a channel that has the NOAA Weather Radio is selected, the RM radio generates an audible voice announcement indicating the channel and weather frequency number. (E.g.: “Channel 8: Weather 1”). The weather frequency number announced is one of the 7 NOAA national frequencies that is currently tuned in the weather radio. The weather frequency can be changed while in the Weather Channel Programming mode by pressing the SB2 button to enter Weather menu and then using the SB1 button to toggle up or SB2 button to toggle down. The PTT button acts as the menu

button to advance to channel menu or weather menu alert menu.

NOAA Weather Alert

The RM series radio is capable of monitoring the NOAA frequency for any alerts issued by the National Weather Service. When the Weather Alert feature is enabled, the radio will “mute” the daily weather radio. You can then move the channel position to a standard 2 way radio frequency and continue with normal communication.

The Weather Alert allows the radio to “listen” for a Warning Alarm Tone (WAT) from the National Weather Service. If a WAT is detected, the weather radio will “un-mute” and the message being broadcasted will be heard on the RM radio.

If the RM radio is tuned to a 2 way channel (normal operation and weather alert feature ON), the radio will “un-mute” and the message being broadcasted will be heard when a WAT is

detected. While monitoring an alert, pressing the PTT button or changing channels exits the weather alert and returns to normal operation.

Note: Using the Weather Alert Feature impacts normal battery life.

CLONING RADIOS

You can clone RM Series radio profiles from one Source radio to a Target radio by using any one of these 3 methods:

- Using a Multi Unit Charger (MUC- optional accessory),
- Using two Single Unit Chargers (SUC) and a Radio-to-Radio cloning cable (optional accessory),
- the CPS (free software download)

Cloning with a Multi Unit Charger (MUC)

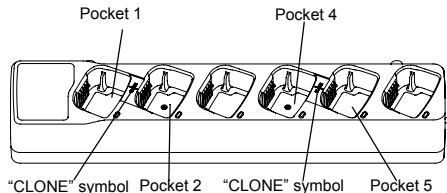

To clone radios using the MUC, there must be at least two radios:

- a Source radio (radio which profiles will be cloned or copied from) and
- a Target radio (the radio which profile will be cloned from the source radio.)

The Source radio has to be in Pocket 1 or 4 while the Target radio has to be in Pocket 2 or 5, matching in the MUCs pockets by pairs as follows:

- 1 and 2 or,
- 4 and 5.

When cloning, the MUC does not need to be plugged into a power source, but ALL radios require charged batteries.

1. Turn ON the Target radio and place it into one of the MUC Target Pockets
2. Power the Source radio following the sequence below:
 - Press the PTT button and SB2

simultaneously while turning the radio ON.

- Wait for 3 seconds before releasing the buttons until the audible tone “Cloning” is heard.
3. Place the Source radio in the source pocket that pairs with the target pocket you chose in step 1. Press and release the SB1 button.
 4. After cloning is completed, the Source radio will announce either “successful” (cloning is successful) or “fail” (cloning has failed). If the Source radio is a display model, it will either show ‘Pass’ or ‘Fail’ on the display (a voice announcement will be played within 5 seconds).
 5. Once you have completed the cloning process, turn the radios OFF and ON or, long press the PTT button to exit the ‘cloning’ mode.

Further details on how to clone radios are explained in the Instructions Sheet provided with the MUC.

When ordering the MUC, refer to P/N# PMLN6384_.

Notes:

- If cloning fails, refer to “What To Do If Cloning Fails” on page 51.
- Paired Target radios and Source radios must be of the same band type in order for the cloning to run successfully.
- MUC pockets numbers should be read from left to right with the Motorola logo facing front.

CPS and Cloning Cables (Optional Accessory)

- Both **CPS** and **Cloning Cables** are made to work either with RM Series radios or RDX Series radios. Cloning cable supports a mix of RM and RDX series radios.
- CPS** cable programs RM series radios. Make sure the cable switch is in “Flash” position. To program a RDX radio with the CPS cable, make sure the cable switch is in “CPS” position and the USB converter provided in the CPS cable kit is attached to the cable.
- Cloning** cable allows you to clone:
 - RM Series radios. Make sure the switch is in “Cloning” or “Legacy” position.
 - RDX Series radios. Make sure the switch is in “Legacy” position with one USB converter on each end of the cloning cable.
 - RM Series and RDX Series radios. Make sure the switch is in “Legacy” position and use a USB converter to the RDX Single-Unit Charger. The Cloning Cable Kit provides 1 USB converter.

CPS Cable

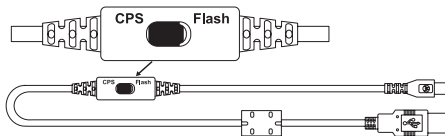

Cloning Cable

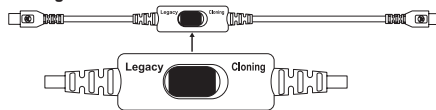

USB Converter

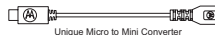

Cloning Radio using the Radio to Radio (R2R) Cloning Cable (Optional Accessory)

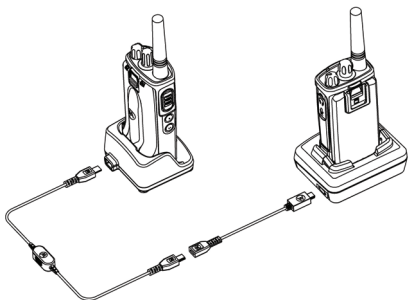

Operating Instructions

1. Before starting the cloning process, make sure you have:
 - A fully charged battery on each of the radios.
 - Two Single-Unit Chargers (SUC), or 2 SUC for cloning RM Series radios, or 1 SUC for RM Series radio and 1 SUC for RDX Series radio.
 - Turn OFF the radios and,
 2. Unplug any cables (power supply or USB cables) from the SUCs.
 3. Plug one side of the cloning cable mini USB connector to the first SUC and the other end to the second SUC.
- Note:** During the cloning process, no power is being applied to the SUC. The batteries will not be charged. Only data communication is being established between the two radios.
4. Turn ON the Target Radio and place it into one of the SUCs.
 5. For the Source Radio, power ON the radio with the following sequence:
 - Press the PTT button and the SB2 button simultaneously while turning the radio ON.
 - Place the Source Radio in its SUC. Press and release the SB1 button.
 6. Wait 3 seconds before releasing the buttons and you hear a distinctive audible tone saying the word “Cloning”.
 7. When the cloning is completed, the Source Radio audible voice will announce either “pass”

(cloning is successful) or “fail” (cloning process has failed). If the Source Radio is a display model radio, it will either show ‘Pass’ or ‘Fail’ on the display (a voice announcement will be played within 5 seconds).

8. Once the cloning process is completed, turn the Radios OFF and ON or, long press the PTT button to exit the ‘cloning’ mode

What To Do If Cloning Fails

The radio audible voice will announce “Fail” indicating that the cloning process has failed. In the event that the cloning fails, perform each of the following steps before attempting to start cloning process again:

1. Ensure that the batteries on both radios are fully charged.
2. Check the cloning cable connection on both SUCs.
3. Ensure that the battery is engaged properly on the radio.

4. Ensure that there is no debris in the charging tray or on the radio contacts.
5. Ensure that the Target radio is turned ON.
6. Ensure that the Source radio is in cloning mode.
7. Ensure that the two radios are both from the same frequency band, same region and have the same transmission power.

Note: This cloning cable is designed to operate only with compatible Motorola SUC RLN6175 and PMLN6394.

When ordering Cloning Cable, please refer to P/N# HKKN4028_. For more information about the accessories, refer to “Accessories” on page 74.

Cloning using the Customer Programming Software (CPS)

When cloning using this method, you need the CPS software, a Drop-In Tray Charger and the CPS Programming Cable.

To order the CPS Programming Cable, please refer to P/N# HKKN4028_.

Information on how to clone using the CPS is available either in:

- the CPS Help File --> Content and Index --> Cloning Radios, or
- in the CPS Programming Cable Accessory Leaflet.

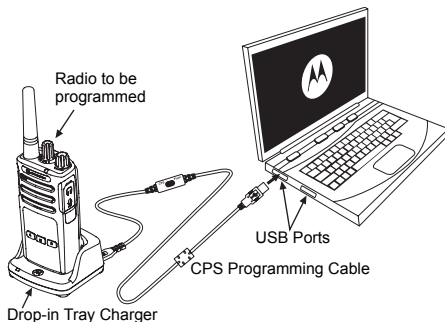

TROUBLESHOOTING

<i>Symptom</i>	<i>Try This...</i>
No Power	Recharge or replace the Li-Ion battery. Extreme operating temperatures may affect battery life. Refer to "About the Li-Ion Battery" on page 14
Hearing other noises or conversation on a channel	Confirm Interference Eliminator Code is set. Frequency or Interference Eliminator Code may be in use. Change settings: either change frequencies or codes on all radios. Make sure radio is at the right frequency and code when transmitting. Refer to "Talking and Monitoring" on page 26
Message Scrambled	Scramble Code might be ON, and/or setting does not match the other radios' settings.
Audio quality not good enough	Radio settings might not be matching up correctly. Double check frequencies, codes and bandwidths to make sure they are identical in all radios

<i>Symptom</i>	<i>Try This...</i>
Limited talk range	<p>Steel and/or concrete structures, heavy foliage, buildings or vehicles decrease range. Check for clear line of sight to improve transmission.</p> <p>Wearing radio close to body such as in a pocket or on a belt decreases range. Change location of radio. To increase range and coverage, you can reduce obstructions or increase power. UHF radios provides greater coverage in industrial and commercial buildings. Increasing power provides greater signal range and increased penetration through obstructions.</p> <p>Refer to “Talking and Monitoring” on page 26</p>
Message not transmitted or received	<p>Make sure the PTT button is completely pressed when transmitting. Confirm that the radios have the same Channel, Frequency, Interference Eliminator Code and Scramble Code settings. Refer to “Talking and Monitoring” on page 26 for further information.</p> <p>Recharge, replace and/or reposition batteries. Refer to “About the Li-Ion Battery” on page 14.</p> <p>Obstructions and operating indoors, or in vehicles, may interfere. Change location. Refer to “Talking and Monitoring” on page 26.</p> <p>Verify that the radio is not in Scan. Refer to “Scan” on page 40 and “Nuisance Channel Delete” on page 41.</p>

Symptom	Try This...
Heavy static or interference	Radios are too close; they must be at least five feet apart. Radios are too far apart or obstacles are interfering with transmission. Refer to “Talking and Monitoring” on page 26.
Low batteries	Recharge or replace Li-Ion battery. Extreme operating temperatures affect battery life. Refer to “About the Li-Ion Battery” on page 14.
Drop-in Charger LED light does not blink	Check that the radio/battery is properly inserted and check the battery/charger contacts to ensure that they are clean and charging pin is inserted correctly. Refer to “Charging the Battery” on page 19, “Drop-in Tray Charger LED Indicators” on page 21 and “Installing the Lithium-Ion (Li-Ion) Battery” on page 16.
Low battery indicator is blinking although new batteries are inserted	Refer to “Installing the Lithium-Ion (Li-Ion) Battery” on page 16, and “About the Li-Ion Battery” on page 14.

<i>Symptom</i>	<i>Try This...</i>
Cannot activate VOX	<p>VOX feature might be set to OFF.</p> <p>Use the CPS to ensure that the VOX Sensitivity level is not set to '0'.</p> <p>Accessory not working or not compatible.</p> <p>Refer to "Hands-Free Use/VOX" on page 30.</p>
Battery does not charge although it has been placed in the drop-in charger for a while	<p>Check drop-in tray charger is properly connected and correspond to a compatible power supply.</p> <p>Refer to "Charging with the Drop-in Tray Single Unit Charger (SUC)" on page 19 and "Charging A Stand-Alone Battery" on page 20.</p> <p>Check the charger's LEDs indicators to see if the battery has a problem. Refer to "Drop-in Tray Charger LED Indicators" on page 21.</p>

Note: Whenever a feature in the radio seems to not correspond to the default or preprogrammed values, check to see if the radio has been programmed using the CPS with a customized profile.

USE AND CARE



Use a soft damp cloth to clean the exterior



Do not immerse in water



Do not use alcohol or cleaning solutions

If the radio is submerged in water...



Turn radio OFF and remove batteries



Dry with soft cloth



Do not use radio until completely dry

FREQUENCY AND CODE CHARTS

RM VHF FREQUENCIES CHART

The charts in this section provide Frequency and Code information. These charts are useful when using the Motorola RM Series two-way radios with other business radios.

VHF Frequencies – BRUS

Frequency #	Frequency (MHz)	Bandwidth
1(*)	151.6250	12.5 kHz
2(*)	151.9550	12.5 kHz
3	152.8850	12.5 kHz
4	152.9150	12.5 kHz
5	151.7000	12.5 kHz
6	151.7600	12.5 kHz
7	152.9450	12.5 kHz
8	151.8350	12.5 kHz
9	151.8050	12.5 kHz
10(*)	151.5125	12.5 kHz
11	151.6550	12.5 kHz
12(*)	151.6850	12.5 kHz
13	151.7150	12.5 kHz
14	151.7450	12.5 kHz

Frequency #	Frequency (MHz)	Bandwidth
15(*)	151.7750	12.5 kHz
16	151.8650	12.5 kHz
17	151.8950	12.5 kHz
18	151.9250	12.5 kHz
19	152.9000	12.5 kHz
20(*)	154.4900	12.5 kHz
21(*)	154.5150	12.5 kHz
22	154.5275	12.5 kHz
23	154.5400	12.5 kHz
24	153.0050	12.5 kHz
25	154.5475	12.5 kHz
26	158.4000	12.5 kHz
27	158.4075	12.5 kHz

Note: (*) Default Frequencies

RMV2080 – VHF DEFAULT FREQUENCIES CHART

RM VHF 8CH Radios Default Frequencies – RMV2080

Channel	Frequency #	Frequency (MHz)	Code	Bandwidth
1	20	154.4900	67.0 Hz	12.5 kHz
2	21	154.5150	67.0 Hz	12.5 kHz
3	1	151.6250	67.0 Hz	12.5 kHz
4	2	151.9550	67.0 Hz	12.5 kHz
5	10	151.5125	67.0 Hz	12.5 kHz
6	12	151.6850	67.0 Hz	12.5 kHz
7	15	151.7750	67.0 Hz	12.5 kHz
8	WC	162.4000	67.0 Hz	12.5 kHz

Note: WC = Weather Channel Frequency

RM UHF FREQUENCIES CHART

RM UHF Frequencies

Frequency #	Frequency (MHz)	Bandwidth
1	464.5000	12.5 kHz
2	464.5500	12.5 kHz
3	467.7625	12.5 kHz
4	467.8125	12.5 kHz
5	467.8500	12.5 kHz
6	467.8750	12.5 kHz
7	467.9000	12.5 kHz
8	467.9250	12.5 kHz
9	461.0375	12.5 kHz
10	461.0625	12.5 kHz
11	461.0875	12.5 kHz
12	461.1125	12.5 kHz
13	461.1375	12.5 kHz
14	461.1625	12.5 kHz

Frequency #	Frequency (MHz)	Bandwidth
15	461.1875	12.5 kHz
16	461.2125	12.5 kHz
17	461.2375	12.5 kHz
18	461.2625	12.5 kHz
19	461.2875	12.5 kHz
20	461.3125	12.5 kHz
21	461.3375	12.5 kHz
22	461.3625	12.5 kHz
23	462.7625	12.5 kHz
24	462.7875	12.5 kHz
25	462.8125	12.5 kHz
26	462.8375	12.5 kHz
27	462.8625	12.5 kHz
28	462.8875	12.5 kHz

RM UHF Frequencies (Continued)

Frequency #	Frequency (MHz)	Bandwidth
29	462.9125	12.5 kHz
30	464.4875	12.5 kHz
31	464.5125	12.5 kHz
32	464.5375	12.5 kHz
33	464.5625	12.5 kHz
34	466.0375	12.5 kHz
35	466.0625	12.5 kHz
36	466.0875	12.5 kHz
37	466.1125	12.5 kHz
38	466.1375	12.5 kHz
39	466.1625	12.5 kHz
40	466.1875	12.5 kHz
41	466.2125	12.5 kHz
42	466.2375	12.5 kHz
43	466.2625	12.5 kHz
44	466.2875	12.5 kHz
45	466.3125	12.5 kHz
46	466.3375	12.5 kHz

Frequency #	Frequency (MHz)	Bandwidth
47	466.3625	12.5 kHz
48	467.7875	12.5 kHz
49	467.8375	12.5 kHz
50	467.8625	12.5 kHz
51	467.8875	12.5 kHz
52	467.9125	12.5 kHz
53	469.4875	12.5 kHz
54	469.5125	12.5 kHz
55	469.5375	12.5 kHz
56	469.5625	12.5 kHz
57	462.1875	12.5 kHz
58	462.4625	12.5 kHz
59	462.4875	12.5 kHz
60	462.5125	12.5 kHz
61	467.1875	12.5 kHz
62	467.4625	12.5 kHz
63	467.4875	12.5 kHz
64	467.5125	12.5 kHz

RM UHF Frequencies (Continued)

Frequency #	Frequency (MHz)	Bandwidth
65	451.1875	12.5 kHz
66	451.2375	12.5 kHz
67	451.2875	12.5 kHz
68	451.3375	12.5 kHz
69	451.4375	12.5 kHz
70	451.5375	12.5 kHz
71	451.6375	12.5 kHz
72	452.3125	12.5 kHz
73	452.5375	12.5 kHz
74	452.4125	12.5 kHz
75	452.5125	12.5 kHz
76	452.7625	12.5 kHz
77	452.8625	12.5 kHz

Frequency #	Frequency (MHz)	Bandwidth
78	456.1875	12.5 kHz
79	456.2375	12.5 kHz
80	456.2875	12.5 kHz
81	456.3375	12.5 kHz
82	456.4375	12.5 kHz
83	456.5375	12.5 kHz
84	456.6375	12.5 kHz
85	457.3125	12.5 kHz
86	457.4125	12.5 kHz
87	457.5125	12.5 kHz
88	457.7625	12.5 kHz
89	457.8625	12.5 kHz

Note: Frequencies #57 to #89 are 33 new additional frequencies

RMU2080 – UHF DEFAULT FREQUENCIES CHART

RM UHF 8CH Radios Default Frequencies – RMU2080

Channel	Frequency #	Frequency (MHz)	Code #	Code	Bandwidth
1	2	464.5500	1	67.0 Hz	12.5 kHz
2	8	467.9250	1	67.0 Hz	12.5 kHz
3	5	467.8500	1	67.0 Hz	12.5 kHz
4	6	467.8750	1	67.0 Hz	12.5 kHz
5	10	461.0625	1	67.0 Hz	12.5 kHz
6	12	461.1125	1	67.0 Hz	12.5 kHz
7	14	461.1625	1	67.0 Hz	12.5 kHz
8	WC	162.4000	1	67.0 Hz	12.5 kHz

Note: WC = Weather Channel Frequency

CTCSS AND PL/DPL CODES

CTCSS Codes

CTCSS	Hz
1	67.0
2	71.9
3	74.4
4	77.0
5	79.7
6	82.5
7	85.4
8	88.5
9	91.5
10	94.8
11	97.4
12	100.0
13	103.5

CTCSS	Hz
14	107.2
15	110.9
16	114.8
17	118.8
18	123
19	127.3
20	131.8
21	136.5
22	141.3
23	146.2
24	151.4
25	156.7
26	162.2

CTCSS	Hz
27	167.9
28	173.8
29	179.9
30	186.2
31	192.8
32	203.5
33	210.7
34	218.1
35	225.7
36	233.6
37	241.8
38	250.3
122 (*)	69.3

Note: (*) New CTCSS code.

PL/DPL Codes

DPL	Code
39	23
40	25
41	26
42	31
43	32
44	43
45	47
46	51
47	54
48	65
49	71
50	72
51	73
52	74
53	114
54	115

DPL	Code
55	116
56	125
57	131
58	132
59	134
60	143
61	152
62	155
63	156
64	162
65	165
66	172
67	174
68	205
69	223
70	226

DPL	Code
71	243
72	244
73	245
74	251
75	261
76	263
77	265
78	271
79	306
80	311
81	315
82	331
83	343
84	346
85	351
86	364

PL/DPL Codes (Continued)

DPL	Code
87	365
88	371
89	411
90	412
91	413
92	423
93	431
94	432
95	445
96	464
97	465
98	466
99	503
100	506
101	516
102	532
103	546

DPL	Code
104	565
105	606
106	612
107	624
108	627
109	631
110	632
111	654
112	662
113	664
114	703
115	712
116	723
117	731
118	732
119	734
120	743

DPL	Code
121	754
123	645
124	Customized PL
125	Customized PL
126	Customized PL
127	Customized PL
128	Customized PL
129	Customized PL
130	Inverted DPL 39
131	Inverted DPL 40
132	Inverted DPL 41
133	Inverted DPL 42
134	Inverted DPL 43
135	Inverted DPL 44
136	Inverted DPL 45
137	Inverted DPL 46
138	Inverted DPL 47

PL/DPL Codes (Continued)

DPL	Code
139	Inverted DPL 48
140	Inverted DPL 49
141	Inverted DPL 50
142	Inverted DPL 51
143	Inverted DPL 52
144	Inverted DPL 53
145	Inverted DPL 54
146	Inverted DPL 55
147	Inverted DPL 56
148	Inverted DPL 57
149	Inverted DPL 58
150	Inverted DPL 59
151	Inverted DPL 60
152	Inverted DPL 61
153	Inverted DPL 62
154	Inverted DPL 63
155	Inverted DPL 64

DPL	Code
156	Inverted DPL 65
157	Inverted DPL 66
158	Inverted DPL 67
159	Inverted DPL 68
160	Inverted DPL 69
161	Inverted DPL 70
162	Inverted DPL 71
163	Inverted DPL 72
164	Inverted DPL 73
165	Inverted DPL 74
166	Inverted DPL 75
167	Inverted DPL 76
168	Inverted DPL 77
169	Inverted DPL 78
170	Inverted DPL 79
171	Inverted DPL 80
172	Inverted DPL 81

DPL	Code
173	Inverted DPL 82
174	Inverted DPL 83
175	Inverted DPL 84
176	Inverted DPL 85
177	Inverted DPL 86
178	Inverted DPL 87
179	Inverted DPL 88
180	Inverted DPL 89
181	Inverted DPL 90
182	Inverted DPL 91
183	Inverted DPL 92
184	Inverted DPL 93
185	Inverted DPL 94
186	Inverted DPL 95
187	Inverted DPL 96
188	Inverted DPL 97
189	Inverted DPL 98

PL/DPL Codes (Continued)

DPL	Code
190	Inverted DPL 99
191	Inverted DPL 100
192	Inverted DPL 101
193	Inverted DPL 102
194	Inverted DPL 103
195	Inverted DPL 104
196	Inverted DPL 105
197	Inverted DPL 106
198	Inverted DPL 107
199	Inverted DPL 108

DPL	Code
200	Inverted DPL 109
201	Inverted DPL 110
202	Inverted DPL 111
203	Inverted DPL 112
204	Inverted DPL 113
205	Inverted DPL 114
206	Inverted DPL 115
207	Inverted DPL 116
208	Inverted DPL 117
209	Inverted DPL 118

DPL	Code
210	Inverted DPL 119
211	Inverted DPL 120
212	Inverted DPL 121
213	Inverted DPL 123
214	Customized DPL
215	Customized DPL
216	Customized DPL
217	Customized DPL
218	Customized DPL
219	Customized DPL

Notes

MOTOROLA LIMITED WARRANTY FOR THE UNITED STATES AND CANADA

What Does this Warranty Cover?

Subject to the exclusions contained below, Motorola, Inc. warrants its telephones, pagers, and consumer and business two-way radios (excluding commercial, government or industrial radios) that operate via Family Radio Service or General Mobile Radio Service, Motorola-branded or certified accessories sold for use with these Products (“Accessories”) and Motorola software contained on CD-ROMs or other tangible media and sold for use with these Products (“Software”) to be free from defects in materials and workmanship under normal consumer usage for the period(s) outlined below.

This limited warranty is a consumer’s exclusive remedy, and applies as follows to new Motorola Products, Accessories and Software purchased by consumers in the United States, which are accompanied by this written warranty.

Products and Accessories

Products Covered	Length of Coverage
Products and Accessories as defined above, unless otherwise provided for below.	One (1) year from the date of purchase by the first consumer purchaser of the product unless otherwise provided for below.
Decorative Accessories and Cases. Decorative covers, bezels, PhoneWrap™ covers and cases.	Limited lifetime warranty for the lifetime of ownership by the first consumer purchaser of the product.
Business Two-way Radio Accessories	One (1) year from the date of purchase by the first consumer purchaser of the product.
Products and Accessories that are Repaired or Replaced.	The balance of the original warranty or for ninety (90) days from the date returned to the consumer, whichever is longer.

Exclusions

Normal Wear and Tear. Periodic maintenance, repair and replacement of parts due to normal wear and tear are excluded from coverage.

Batteries. Only batteries whose fully charged capacity falls below 80% of their rated capacity and batteries that leak are covered by this limited warranty.

Abuse & Misuse. Defects or damage that result from: (a) improper operation, storage, misuse or abuse, accident or neglect, such as physical damage (cracks, scratches, etc.) to the surface of the product resulting from misuse; (b) contact with liquid, water, rain, extreme humidity or heavy perspiration, sand, dirt or the like, extreme heat, or food; (c) use of the Products or Accessories for commercial purposes or subjecting the Product or Accessory to abnormal usage or conditions; or (d) other acts which are not the fault of Motorola, are excluded from coverage.

Use of Non-Motorola Products and Accessories.

Defects or damage that result from the use of Non-Motorola branded or certified Products, Accessories, Software or other peripheral equipment are excluded from coverage.

Unauthorized Service or Modification. Defects or damages resulting from service, testing, adjustment, installation, maintenance, alteration, or modification in any way by someone other than Motorola, or its authorized service centers, are excluded from coverage.

Altered Products. Products or Accessories with (a) serial numbers or date tags that have been removed, altered or obliterated; (b) broken seals or that show evidence of tampering; (c) mismatched board serial numbers; or (d) nonconforming or non-Motorola housings, or parts, are excluded from coverage.

Communication Services. Defects, damages, or the failure of Products, Accessories or Software due to any communication service or signal you may subscribe to or use with the Products Accessories or Software is excluded from coverage.

Software

Products Covered	Length of Coverage
Software. Applies only to physical defects in the media that embodies the copy of the software (e.g. CD-ROM, or floppy disk).	Ninety (90) days from the date of purchase.

Exclusions

Software Embodied in Physical Media. No warranty is made that the software will meet your requirements or will work in combination with any hardware or software applications provided by third parties, that the operation of the software products will be uninterrupted or error free, or that all defects in the software products will be corrected.

Software NOT Embodied in Physical Media.

Software that is not embodied in physical media (e.g. software that is downloaded from the internet), is provided “as is” and without warranty.

WHO IS COVERED?

This warranty extends only to the first consumer purchaser, and is not transferable.

HOW TO OBTAIN WARRANTY SERVICE OR OTHER INFORMATION?

Contact your Motorola point of purchase.

SOFTWARE COPYRIGHT NOTICE

The Motorola products described in this manual may include copyrighted Motorola and third party software stored in semiconductor memories or other media. Laws in the United States and other countries preserve for Motorola and third party software providers certain exclusive rights for copyrighted software, such as the exclusive rights to distribute or reproduce the copyrighted software. Accordingly, any copyrighted software contained in the Motorola products may not be modified, reverse-engineered, distributed, or reproduced in any manner to the extent allowed by law.

Furthermore, the purchase of the Motorola products shall not be deemed to grant either directly or by implication, estoppel, or otherwise, any license under the copyrights, patents, or patent applications of Motorola or any third party software provider, except for the normal, non-exclusive, royalty-free license to use that arises by operation of law in the sale of a product.

PATENT NOTICE

This product is covered by one or more of the following United States patents.

5896277 5894292 5864752 5699006 5742484
D408396 D399821 D387758 D389158 5894592
5893027 5789098 5734975 5861850 D395882
D383745 D389827 D389139 5929825 5926514
5953640 6071640 D413022 D416252 D416893
D433001

EXPORT LAW ASSURANCES

This product is controlled under the export regulations of the United States of America. The Governments of the United States of America may restrict the exportation or re-exportation of this product to certain destinations. For further information contact the U.S. Department of Commerce.

ACCESSORIES

AUDIO ACCESSORIES

Part No.	Description
53815	Headset w/Boom Mic BR
HMN9026_R	Remote Speaker Mic BR
HKLN4477_	Surveillance Earpiece BR
53865	Headset w/Swivel Boom Mic
53866	Earbud w/Clip PTT Mic BR
56517	Earpiece w/Inline Mic
RLN6423_	Swivel Earpiece BR

BATTERY

Part No.	Description
PMNN4434_R	Standard Li-Ion Battery
PMNN4453_R	High Capacity Li-Ion Battery

CABLES

Part No.	Description
HKKN4028_	Radio to Radio Cloning Cable
HKKN4027_	CPS Programming Cable

CHARGERS

Part No.	Description
PMLN6384_	Multi-Unit Charger (MUC) Kit - North America
PMLN6394_	Standard Drop-In Tray Charger

CARRY ACCESSORIES

Part No.	Description
HKLN4510_	Swivel Holster

SOFTWARE APPLICATIONS

Part No.	Description
82012694001	Customer Programming Software (CPS)

Notes



Two Way Radio Center

www.twowayradiocenter.com

1-855-354-6660



MOTOROLA

Motorola Solutions, Inc.
1301 E. Algonquin Rd.
Schaumburg, IL 60196-1078, U.S.A.
<http://www.motorolasolutions.com>

MOTOROLA, MOTO, MOTOROLA SOLUTIONS and the Stylized M logo are trademarks or registered trademarks of Motorola Trademark Holdings, LLC and are used under license. All other trademarks are the property of their respective owners.

© 2013 Motorola Solutions, Inc.
All rights reserved.



68012009072-A

